



MELIÁ
HOTELS & RESORTS

presents

Meliá Madrid Princesa

Deja que el alma de Madrid te envuelva

Let the soul of Madrid envelop you



El alma de Madrid más cosmopolita y genuino

Bienvenido al lugar donde todo tiene alma. Auténtico emblema de la capital de España. Un hotel urbano de cinco estrellas, elegante y vanguardista. Arraigado en el corazón de la ciudad, es el alojamiento perfecto para estancias de placer y de negocios. Aprovecha su insuperable ubicación, sus confortables instalaciones y sus servicios de primera categoría, mejorados por las ventajas del atributo superior The Level.

Deja que el alma de Madrid te envuelva.

En pleno centro histórico de Madrid, junto a Plaza de España, Gran Vía, el Palacio Real y la puerta del Sol. A 13km del aeropuerto internacional de Adolfo Suárez Madrid Barajas.

The heart of the most cosmopolitan and authentic Madrid

Welcome to the place where everything has soul. A genuine icon in the capital of Spain. An elegant yet avant-garde five-star urban hotel. With a prime location in the heart of the city, this is the perfect accommodation for both business and leisure travelers. Make the most of its unbeatable location, comfortable facilities and first-class services, all further enhanced by the benefits of the superior The Level service.

Let the soul of Madrid envelop you

In the very historical center of Madrid, next to Plaza de España, Gran Vía, the Palacio Real and Puerta del Sol. 13km away from the international airport of Adolfo Suárez Madrid Barajas.



Habitaciones y Suites

273 habitaciones de diferentes categorías, Meliá, Premium, Familiar, The Level: Suite, Junior Suite, Grand Premium, Grand Suite Princesa y Presidential Suite. Habitaciones para discapacitados. Wi-Fi gratuito. Servicio de habitaciones 24 horas. Servicio The Level con espacios privados para clientes, atención personalizada y servicio exclusivo.

Rooms and Suites

273 rooms of different categories, Meliá, Premium, Family, The Level: Suite, Junior Suite, Grand Premium, Grand Suite Princesa y Presidential Suite. Rooms for disable people. Free Wi-Fi. Room service 24hrs. The Level service in private areas for clients, customized attention and exclusive service.



LEVEL

THE LEVEL

En el nuevo espacio The Level los clientes podrán disfrutar de una estancia VIP, efectuar el check-in en un área privada, tener un servicio dedicado de conserjería, acceder a un lounge exclusivo con servicio "a la carta" de desayuno con show cooking, snacks y bebidas, y disponer de una sala de reuniones durante dos horas. El renovado y ampliado lounge cuenta con un nuevo y acogedor espacio gracias a su mobiliario de diseño y la cálida luz natural. Además, las habitaciones de The Level son estancias de categoría superior que se caracterizan por su ubicación en un área privada del hotel, diseño minimalista y atenciones especiales, en las que se ha rediseñado el mobiliario así como la ropa de cama y algunos otros elementos decorativos.

At the new space The Level, the clients could enjoy a VIP stay, do the check-in in a private area, a dedicated concierge service, access to an exclusive "a la carte" breakfast with show cooking, snacks and beverages service lounge. A complimentary private meeting room for two hours. The renovated and extended lounge counts with a new and cozy space thanks to its designed furniture and warm natural lighting. Also, The Level rooms are a superior category stays that are characterized by its private location within the hotel, its minimalist designed and its special attentions, in which the furniture has been redesigned as long as its linens and some other decorative elements.

Experiencias Gastronómicas

Restaurante Mosaico: un nuevo concepto de cocina para todos los gustos que pone a disposición de los clientes apasionados de la buena comida, diferentes ofertas gastronómicas en un espacio decorado con un estilo nórdico contemporáneo y cálida iluminación. Servicio propio de comida y bebida para banquetes y convenciones. Buffet de desayuno con productos locales e internacionales. Lounge Bar.

Gastronomic Experiences

Mosaico Restaurant: a new concept of cuisine for food lovers looking forward to tasting different gastronomic offers in a space decorated with a contemporary Nordic style and warm lighting. In-house food and beverage service for banquets and conventions. Breakfast buffet with local and international products. Lounge Bar.



Reuniones

1875 m2 en 23 salas de reuniones, dotadas en su mayoría con luz natural, con capacidad máxima hasta 600 personas. Equipos audiovisuales en todas las salas de reunión. Gimnasio y YHI Wellness.

Meetings

1875 m2 among 23 meeting rooms, most of them with natural lighting and capacity up to 600 guests. Audiovisual equipments in each meeting room. Gym and YHI Wellness.

SALONES, DIMENSIONES Y CAPACIDADES
 MEETING ROOMS, MEASUREMENTS & CAPACITIES

SALAS DE REUNIONES MEETING ROOMS	M ² SQM	SUP. EN METROS. SIZE IN METERS	LUZ NATURAL NATURAL LIGHT	CÓCTEL COCKTAIL	TEATRO THEATER	ESCUELA CLASSROOM	CABARET CABARET	BANQUETE BANQUET	IMPERIAL IMPERIAL	EN "U" "U" SHAPE
RETIRO 1	33	4,60 x 7,35 x 2,50	NO	-	-	-	-	-	12	-
RETIRO 2	33	4,60 x 7,65 x 2,50	NO	-	-	-	-	-	12	-
RETIRO 3	21	3,90 x 5,90 x 2,50	NO	-	18	-	-	-	12	9
RETIRO 4	20	3,85 x 5,45 x 2,50	NO	-	18	-	-	-	12	9
RETIRO 5	17	3,30 x 5,45 x 2,50	NO	-	18	-	-	-	12	9
RETIRO 6	50	7,00 x 7,50 x 2,50	NO	-	40	18	-	-	18	16
RETIRO 7	18	5,00 x 3,85 x 2,50	NO	-	20	-	-	-	6	8
RETIRO 8	18	5,00 x 3,85 x 2,51	NO	-	20	-	-	-	6	8
RETIRO 3+4	41	-	NO	-	40	18	-	-	12	14
RETIRO 7+8	36	-	NO	-	40	15	-	-	18	14
RETIRO 6+7+8	86	-	NO	-	50	18	-	-	28	26

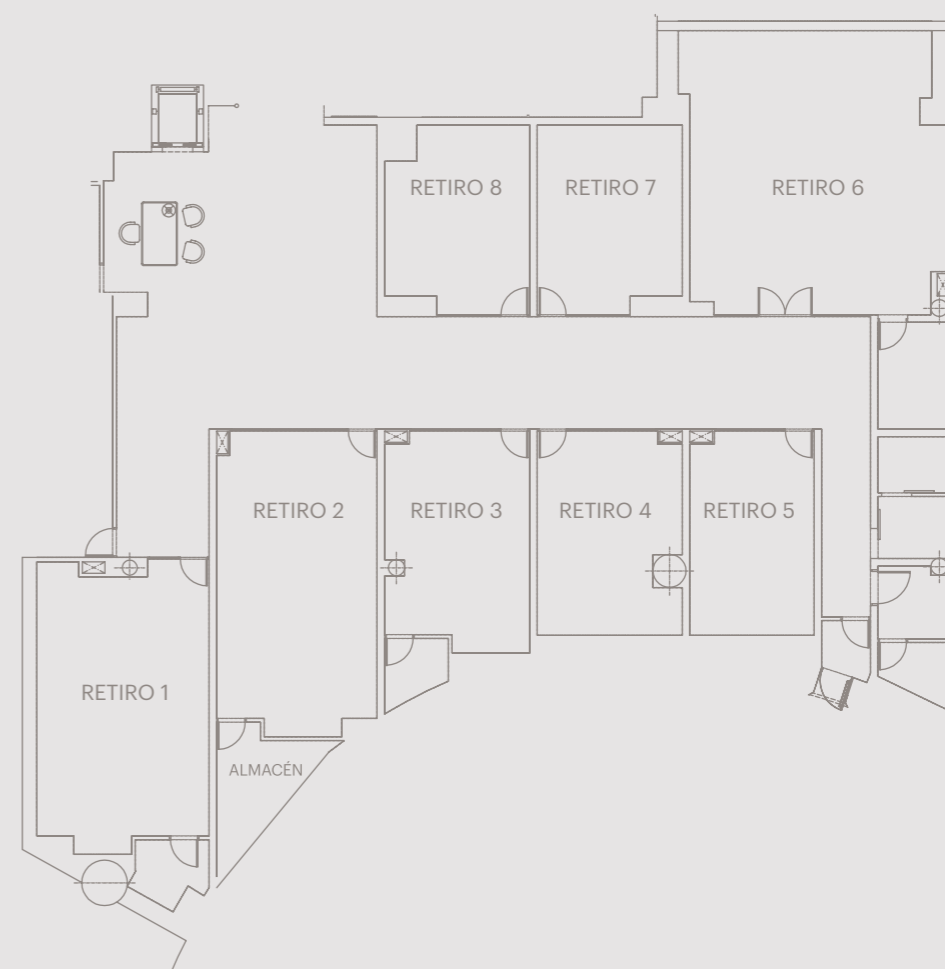

PLANTAO

0 FLOOR

SALONES, DIMENSIONES Y CAPACIDADES
MEETING ROOMS, MEASUREMENTS & CAPACITIES

SALAS DE REUNIONES MEETING ROOMS	M ² SQM	SUP. EN METROS. SIZE IN METERS	LUZ NATURAL NATURAL LIGHT	CÓCTEL COCKTAIL	TEATRO THEATER	ESCUELA CLASSROOM	CABARET CABARET	BANQUETE BANQUET	IMPERIAL IMPERIAL	EN "U" "U" SHAPE
MADRID	149	19,40 x 7,70 x 2,60	NO	120	120	60	63	100	44	42
MADRID I	74	9,50 x 7,70 x 2,60	NO	60	50	25	29	45	22	18
MADRID II	74	9,70 x 7,70 x 2,60	NO	60	50	25	29	45	22	18
LIRIA	67	9,86 x 6,38 x 2,50	NO	40	50	24	29	32	18	24
ORIENTE	111	14,91 x 7,46 x 2,37	NO	70	70	38	42	48	24	33
FLEXY ROOM	32	6,36 x 4,21 x 2,36	NO	-	10	10	-	16	8	10
TECH ROOM	30	6,36 x 4,23 x 2,20	NO	-	-	-	-	12	14	-

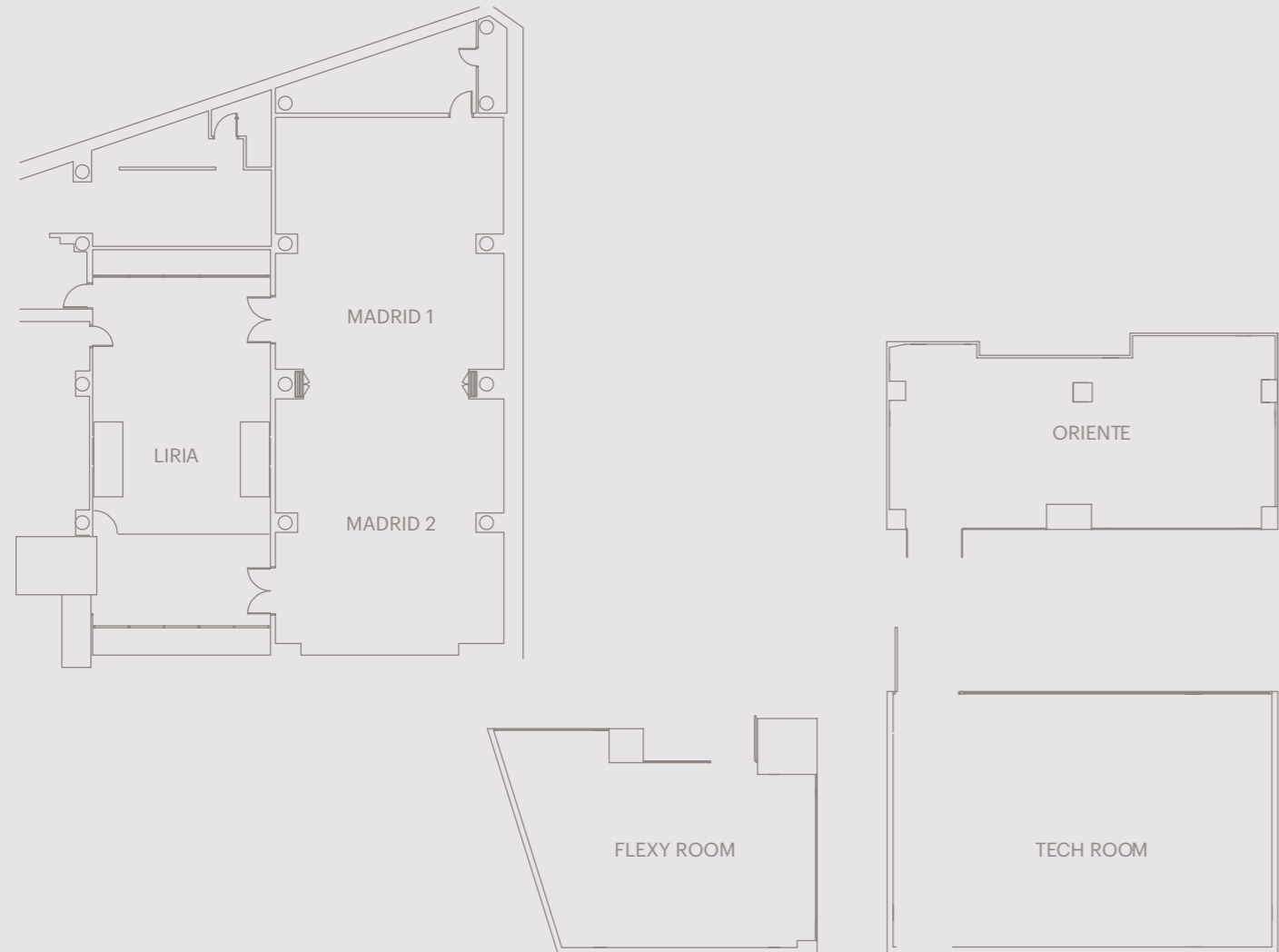

PLANTA1

1ST FLOOR

SALONES, DIMENSIONES Y CAPACIDADES
MEETING ROOMS, MEASUREMENTS & CAPACITIES

SALAS DE REUNIONES MEETING ROOMS	M ² SQM	SUP. EN METROS. SIZE IN METERS	LUZ NATURAL NATURAL LIGHT	CÓCTEL COCKTAIL	TEATRO THEATER	ESCUELA CLASSROOM	CABARET CABARET	BANQUETE BANQUET	IMPERIAL IMPERIAL	EN "U" "U" SHAPE
MOSAICO	414	22,50 x 18,00 x 2,60	SÍ	240	-	-	-	210	-	-
CIBELES	204	14,70 x 15,30 x 2,60	SÍ	280	-	-	-	250	-	-
MOSAICO+CIBELES	629	36,70 x 18,40 x 2,60	SÍ	240	-	-	-	270	-	-

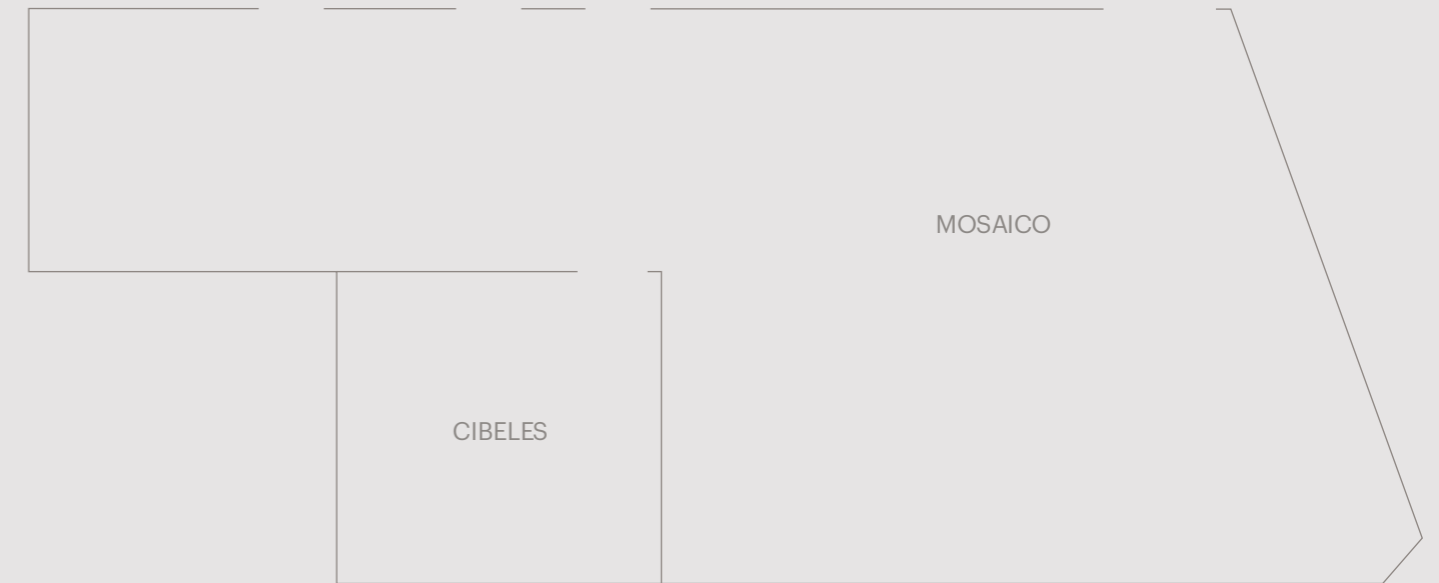

PLANTA 2

2ND FLOOR

SALONES, DIMENSIONES Y CAPACIDADES
MEETING ROOMS, MEASUREMENTS & CAPACITIES

SALAS DE REUNIONES MEETING ROOMS	M ² SQM	SUP. EN METROS. SIZE IN METERS	LUZ NATURAL NATURAL LIGHT	CÓCTEL COCKTAIL	TEATRO THEATER	ESCUELA CLASSROOM	CABARET CABARET	BANQUETE BANQUET	IMPERIAL IMPERIAL	EN "U" "U" SHAPE
PRADO	35	4,90 x 7,20 x 2,60	SÍ	-	25	18	-	30	8	18
NEPTUNO	25	2,20 x 5,20 x 2,60	SÍ	-	-	-	-	-	12	-

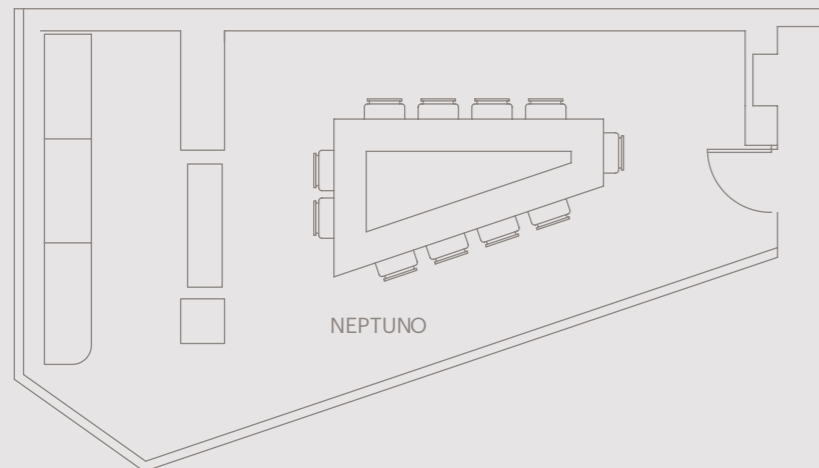
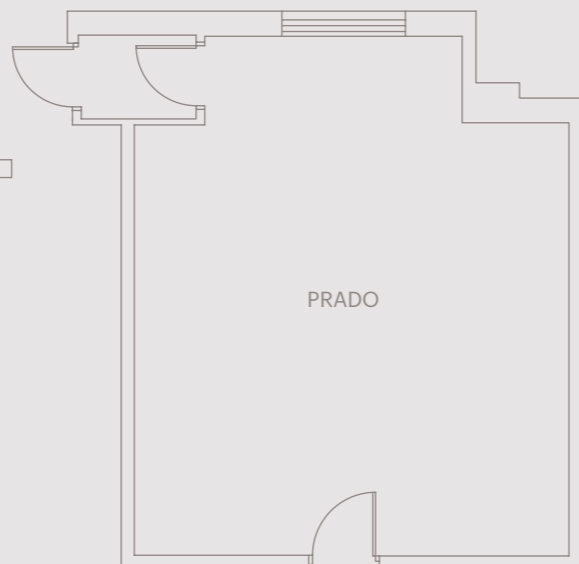

PLANTA 3

3RD FLOOR

SALONES, DIMENSIONES Y CAPACIDADES
MEETING ROOMS, MEASUREMENTS & CAPACITIES

SALAS DE REUNIONES MEETING ROOMS	M ² SQM	SUP. EN METROS. SIZE IN METERS	LUZ NATURAL NATURAL LIGHT	CÓCTEL COCKTAIL	TEATRO THEATER	ESCUELA CLASSROOM	CABARET CABARET	BANQUETE BANQUET	IMPERIAL IMPERIAL	EN "U" "U" SHAPE
SABATINI	600	-	SÍ	600	-	-	-	425	-	-
SABATINI I+II	423	28,60 x 16,3 x 2,85	SÍ	400	400	210	140	290	80	80
SABATINI I	265	19,16 x 16,3 x 2,85	SÍ	300	250	120	90	180	48	50
SABATINI II	158	9,50 x 16,3 x 2,85	SÍ	100	130	72	49	90	40	50
SABATINI III	184	15,13 x 12,14 x 2,20	SÍ	120	50	-	-	110	30	23

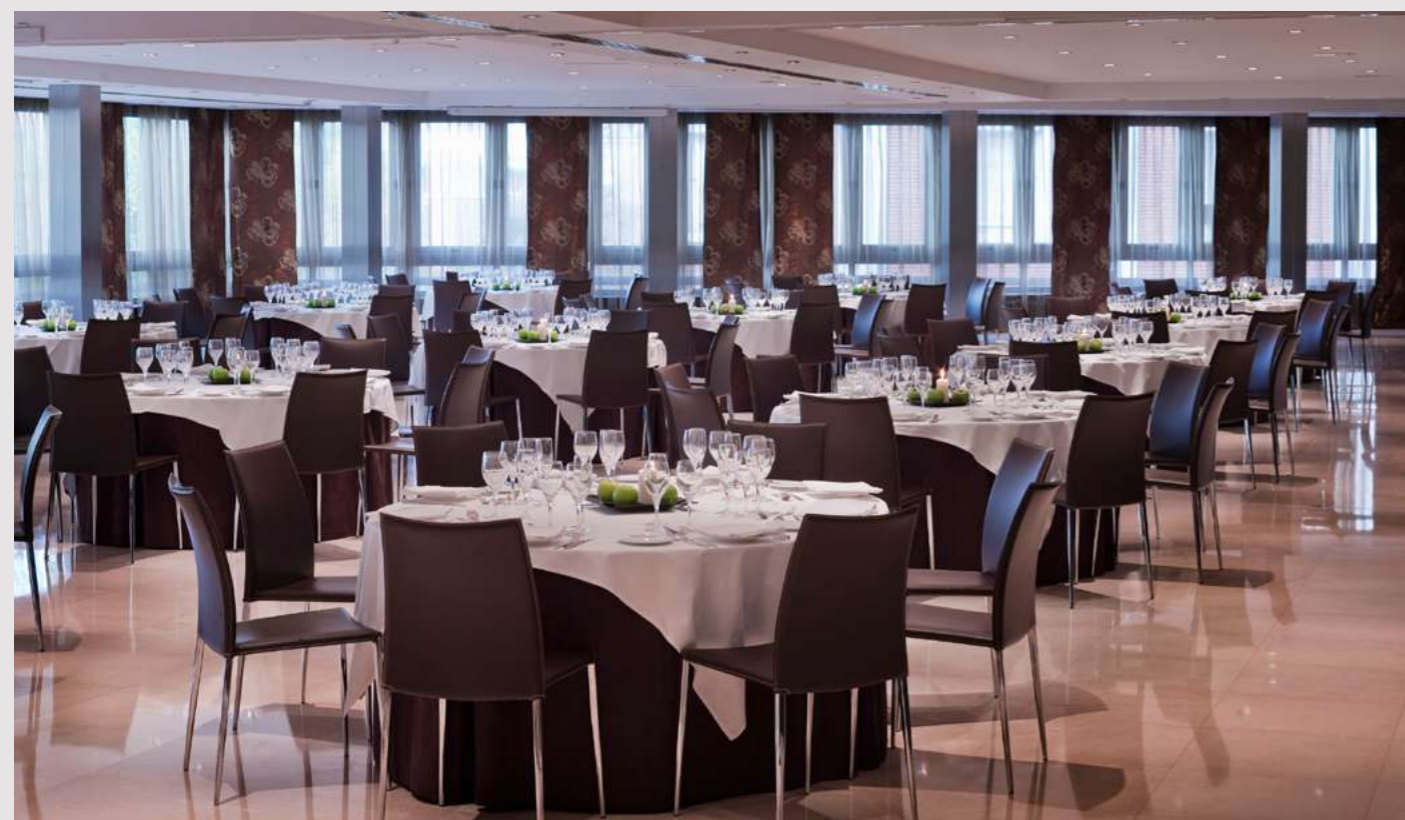
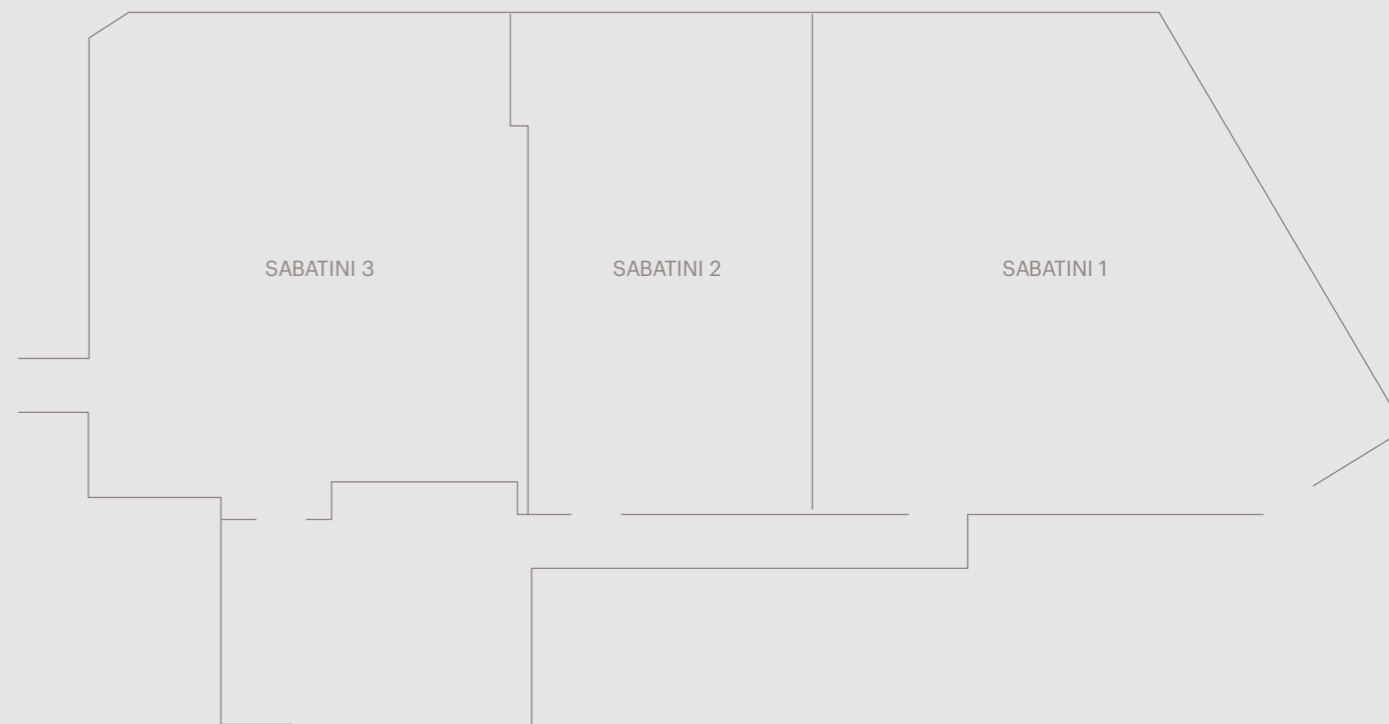



MELIÀ
HOTELS & RESORTS

Soul Matters

Meliá Madrid Princesa
C./ Princesa, 27 28008 Madrid · Spain
+34 91 541 82 00 · groups.madrid@melia.com
melia.com